



Quick Installation Manual

Please scan the following QR code for IntelliHome-16kWh-OD Series User Manual

01 Important Safety Instructions

Danger! High voltage in the battery poses a risk to life! All work must be performed by a qualified electrician. This equipment must not be used by children or individuals with physical, sensory, or mental disabilities, or those lacking experience and knowledge, unless they are under supervision or instruction.

Warning! Electric shock hazard! Authorized service personnel must disconnect the AC and DC power before attempting any maintenance, cleaning, or working on any circuit connected to the system. Do not operate the system while the equipment is running. The battery system can only be used in the DVC-A circuit and can only be used in conjunction with an isolated PCS.

Notice Battery grounding. Comply with local battery grounding requirements. It is recommended to connect the generator frame and other conductive surfaces in a way that ensures continuous electrical conductivity and ground them to provide optimal system and personnel protection. Recommend adding a circuit breaker to the negative pole (the circuit breaker needs to be self equipped)

Setting of Safety Warning Signs

Follow the instructions below during guidance, maintenance, and repair to prevent misuse or accidents caused by non-professionals:

- Place visible signs at both ends of switches to avoid accidents caused by incorrect operation.
- Set up warning signs or isolation barriers near the operating area.
- After maintenance or operation, the system must be reinstalled.

Measuring Equipment

To ensure electrical parameters meet the requirements, relevant measuring equipment is required when connecting or testing the system. Ensure that the equipment used is of matching specifications to prevent arcing or electric shock.

Moisture Protection

Moisture can damage the battery. During maintenance or servicing, avoid operating in damp weather.

Post-Power-Off Operations

The battery system is part of an energy storage system, and even if the DC power is turned off, it may still store life-threatening high voltage. Do not touch the battery socket. Even if the DC or AC power is cut off, the battery pack may still maintain life-threatening voltage. For safety, use a calibrated voltmeter to check the voltage before any installation personnel operate the equipment.

Proper Disposal and Recycling

Dispose of and recycle batteries correctly according to the waste battery management regulations of different countries.

External aural-visual alarm

When venting of gaseous electrolyte, burning of the cell, spark formation and ignition of vented gas mixtures, explosion of the cell, the energy storage system will activate audible and visual alarms via RS485 or CAN communication commands. Simultaneously, the red "SYS" indicator on the PCS front panel will illuminate. The alarm device shall meet the requirement that the sound pressure level at 3meters is greater than 85 dB but not exceeding 110 dB.

Battery Safety Regulations

Hazard Information

This product uses lithium iron phosphate batteries and complies with the United Nations recom-

mendations for the transport of dangerous goods, having passed testing and obtained UN38.3 certification. The battery contains chemicals stored in sealed metal casings designed to withstand the temperatures and pressures encountered during normal use. Therefore, there are no physical hazards of fire or explosion, nor chemical hazards of dangerous goods leakage under normal usage conditions. However, if the product is misused, subjected to fire, mechanical shock, electrical stress, or decomposition, gas release vents will be activated. The outer casing of the battery will be destroyed to the limit, potentially releasing harmful substances.

Safety Data Sheet

For more information, please refer to the battery Safety Data Sheet.

General Precautions

Warning! There is a risk of chemical burns from electrolyte or toxic gases. Under normal operation, there will be no electrolyte leakage or toxic gas emissions from the battery pack. However, if the battery pack is damaged or malfunctioning, electrolyte leakage or toxic gas emissions may occur.

- Do not touch the battery with wet hands.
- Do not install or operate the battery in potentially explosive environments or high humidity areas.
- If moisture penetrates the battery (e.g., due to casing rupture), do not install or operate the battery.
- Do not move equipment connected to the battery module. Secure the equipment to prevent tipping.
- The battery pack must be transported by the manufacturer or designated personnel. Precautions should be documented and archived.
- During transportation, a fire extinguisher with a minimum capacity of 2 kg and ABC certification must be carried.
- Do not smoke inside or near the vehicle during loading or unloading.
- If necessary, when replacing the battery module, request new hazardous material packaging from the supplier, then repack it and return it to the supplier for recycling.
- If electrolyte comes into contact with skin, immediately rinse with clean water and seek medical attention.
- There is a risk of injury when handling or dropping the equipment. The battery pack is heavy. If the battery is improperly lifted or dropped during transportation, installation or removal from the wall, there is a risk of injury.
- If the user chooses to install an external sound and light alarm, please contact the manufacturer to confirm the appropriate alarm and detailed wiring method.

Limitation of Liability

Solisstorage shall not be liable for any direct or indirect damage to products or property caused by the following situations:

- Unauthorized modifications, design changes, or part replacements of the product;
- Alteration, modification, or erasure of serial numbers or seals by non-technical personnel;
- Failure to comply with local safety regulations (e.g., DE: VDE; AU: SAA);
- Damage during transportation (including paint scratches due to friction within the packaging); claims should be filed immediately with the transportation or insurance company after unloading the container/ packaging and confirming the damage;
- Failure to follow any/all user manuals, installation guides, and maintenance rules;
- Improper or misuse of the equipment;
- Inadequate ventilation for the equipment;
- Failure to maintain according to standard maintenance procedures;
- Force majeure (e.g., storms, lightning, fire, etc.);
- Any damage caused by external factors.

Symbols On The Type Label

Symbol	Explanation
	CE marking The battery complies with applicable CE requirements.
	TUV marking
	The battery should be recycled in appropriate facilities in an environmentally safe manner.
	High voltage in the battery poses a risk to life!
	Danger Risk of electric shock!
	Read instructions.
	The system should not be disposed of with household waste. Disposal information can be found in the accompanying documentation.
	Do not dispose of the system together with household waste. Instead, it should be disposed of in accordance with the regulations on electronic waste disposal applicable to the installation site.
	Warning: Explosive Hazard!
	Keep the battery module away from open flames or ignition sources.

Installation Precautions

The IntelliHome-16kWh-OD Series is specifically designed for outdoor installation (IP66). Ensure the installation location meets the following conditions:

- Not exposed to direct sunlight.
- Not in areas with combustible materials stored at high levels.
- Not in potentially explosive areas.
- Not in direct cold air.
- Not near television antennas or antenna cables.
- Altitude not exceeding approximately 3000 meters above sea level.
- Not in environments with precipitation or humidity (>95%).
- Installed in an area with good ventilation.
- Environmental temperature between -20°C and +55°C.

Wall requirements for battery installation:

- The surface should be solid and flat.
- Sturdy brick/concrete or an installation surface of equivalent strength.
- If the wall is not strong enough, the battery must be supported or reinforced (e.g., wooden walls or walls covered with thick layers of decoration).
- Do not install the device in areas with vibration.
- If wall mounted installation is chosen, please ensure that the wall can withstand three times the weight of the product.

Please avoid direct sunlight exposure, rain exposure, or snow accumulation during installation and operation.

Installation Location And Environment

Restricted Locations

Do not install the Battery system in the following locations:

- Locations restricted by AS/NZS 3000 panel regulations;
- Within 600mm of any heat sources (such as water heater units, gas heaters, air conditioning units, or any other equipment);
- Within 600mm of any exit;
- Within 600mm of any window or ventilation opening;
- Within 900mm of any point connected to 240V AC power supply;
- Within 600mm of the sides of any other equipment.

Ensure that when the battery is installed in any corridor, hallway, or similar location leading to an emergency exit, there is a sufficient distance of at least 1 meter from the safety exit.

Residential Partition

To prevent fire from spreading within the space where the energy storage system is installed, install a non-combustible partition on the side of the wall or structural surface opposite the energy storage system. If the installation surface is not made of non-combustible material, a non-com bustible partition can be installed between the energy storage system and the wall or structural surface.

If the energy storage system is installed on the wall separating the energy storage system from the living space or within 300mm of the wall, the distance from other structures or objects must be increased. Please ensure the following distances are maintained:

- At least 300mm distance on both sides of the battery;
- At least 300mm distance above the battery;
- The gap between multiple units must be at least 300mm.

If the energy storage system has less than 50mm clearance between the ceiling or any object above, the ceiling or the surface of the upper structure must be made of non-combustible material, and the radius should be within 600mm.

The maximum distance between the highest point of the installed energy storage system and the floor or platform should not exceed 2.2 meters.

Weight distribution diagrams showing personnel carrying heavy objects. A notice states: "When carrying heavy objects, you should be prepared to bear the weight to avoid being crushed or sprained by heavy objects." A warning symbol notes: "When multiple people carry heavy objects at the same time, it is necessary to consider the height and other conditions, and do a reasonable job of personnel matching and division of labor to ensure a balanced weight distribution."

02 Installation Accessory Checklist

Check the following parts list to ensure all accessories are complete. (Example for installing one battery packs)

Battery Packing List				
Battery system*1	Wall bracket*1	B+ to PCS power cable*1	B- to PCS power cable*1	Communication line*1
RH45 waterproof connector*2	Expansion bolt M6*60*2	Quick Installation Manual*1	Ground wire*1	Outgoing Inspection Report*1
Battery Packing List*1	Screws M6X14*1	Screws M4X12*2	Spirit level*1	Screws M4X6*1
Cover plate*1	N/A	N/A	N/A	N/A

*The above are standard configurations; Please choose the configuration based on the actual shipment!
*Accessories need to be purchased according to actual usage

03-A Floor Standing Installation

01 Select Drilling Location:

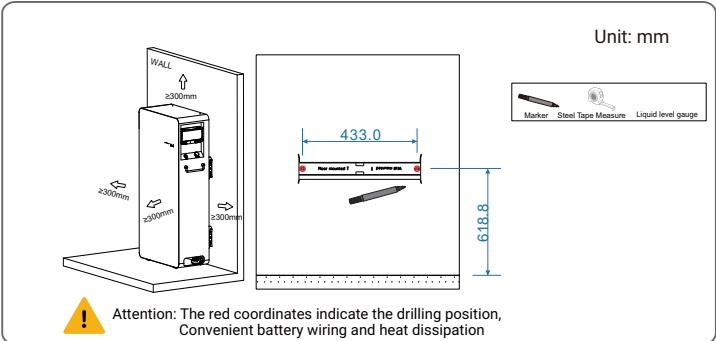

02 Position And Drill Holes, And Install The Expansion screws

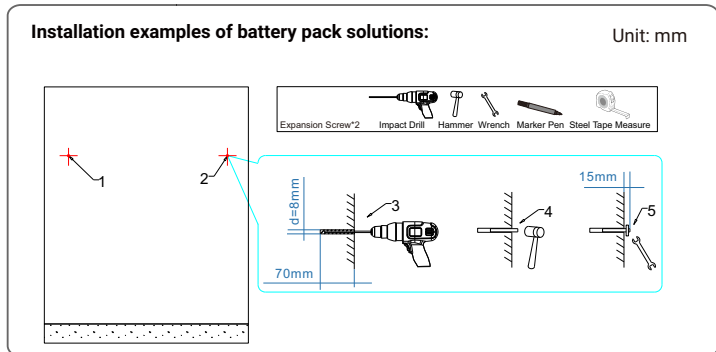

03 Install The Wall bracket:

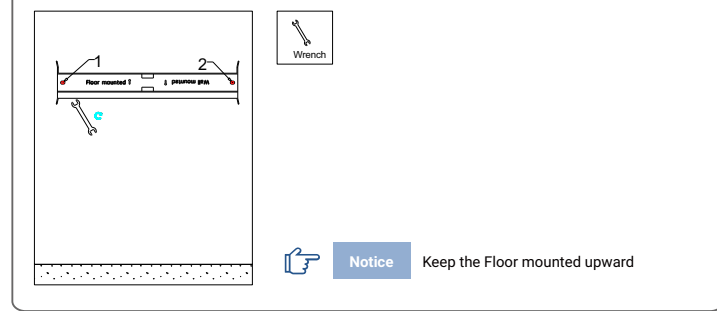

03 Install The Battery System:

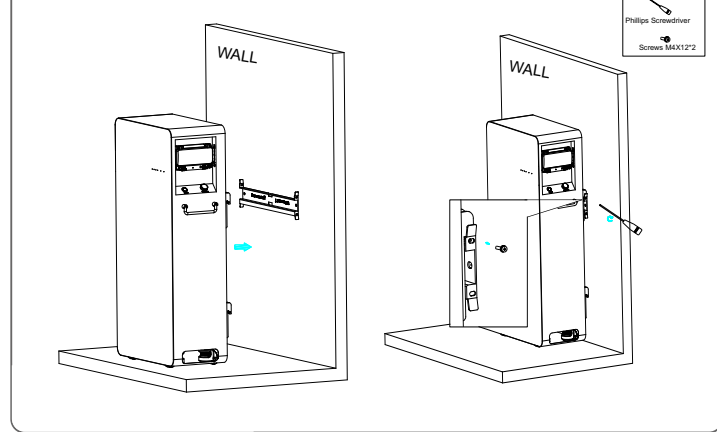

03-B Wall Mounted Installation

01 Select Drilling Location:

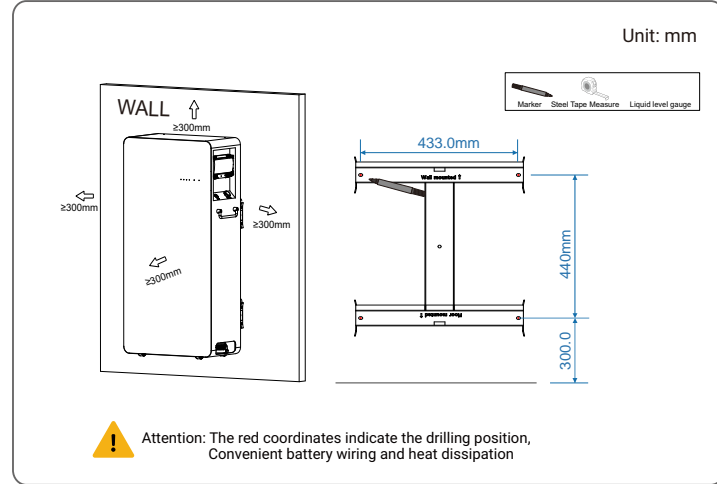

02 Position And Drill Holes, And Install The Expansion screws

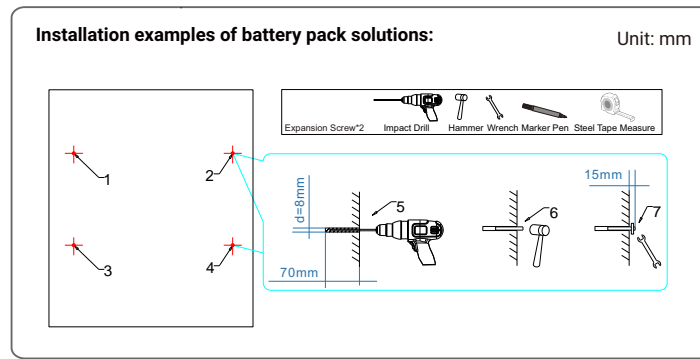

03 Install The Wall bracket:

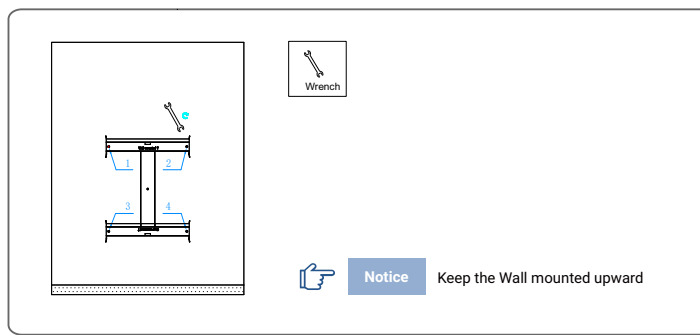

03 Install The Battery System:

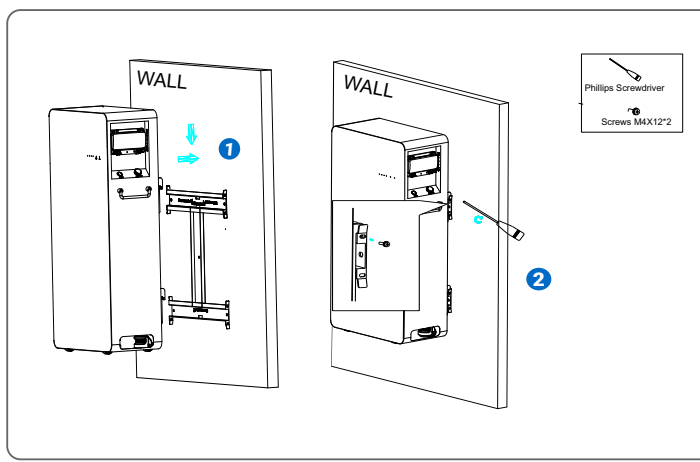

04 Electrical Interface Guidelines

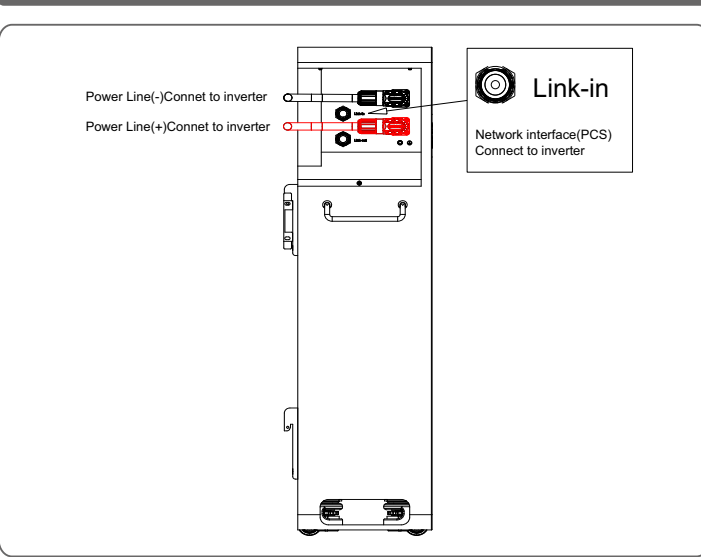

05 Installation of Grounding Wire

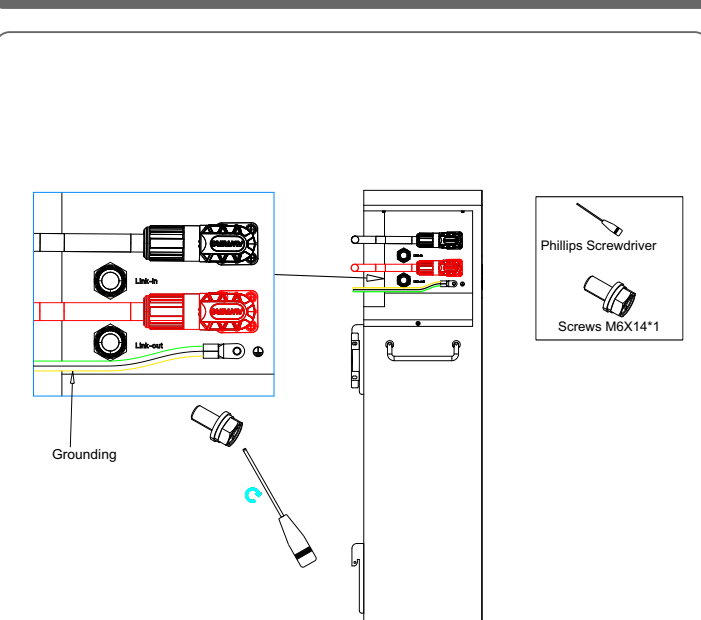

06 Battery system electrical parallel connection Guidelines

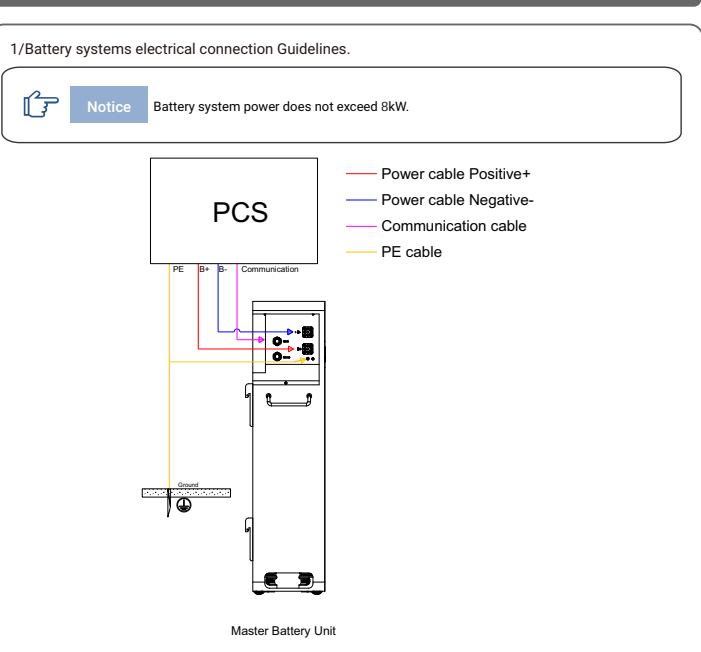

2/Multiple Battery systems electrical parallel connection Guidelines.

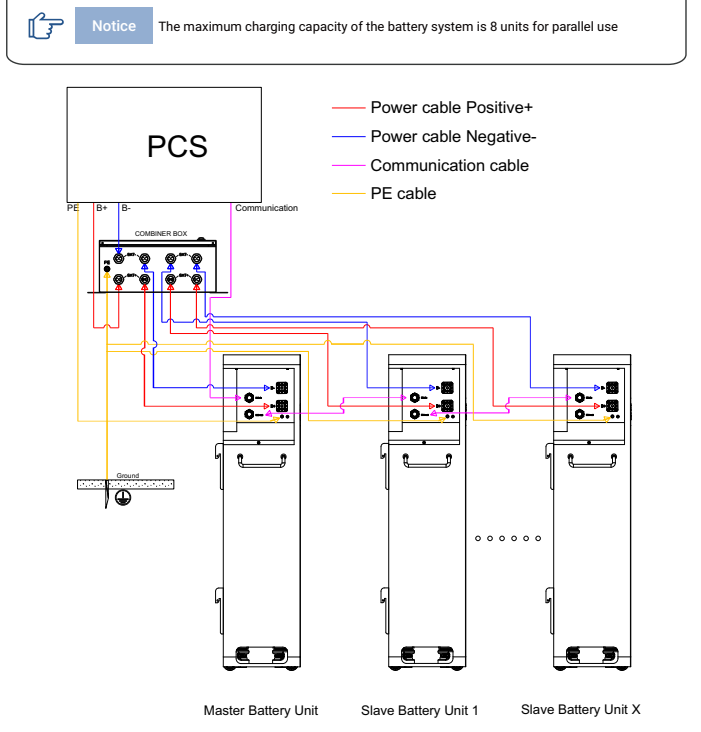

07 Cover platel Interface Guidelines

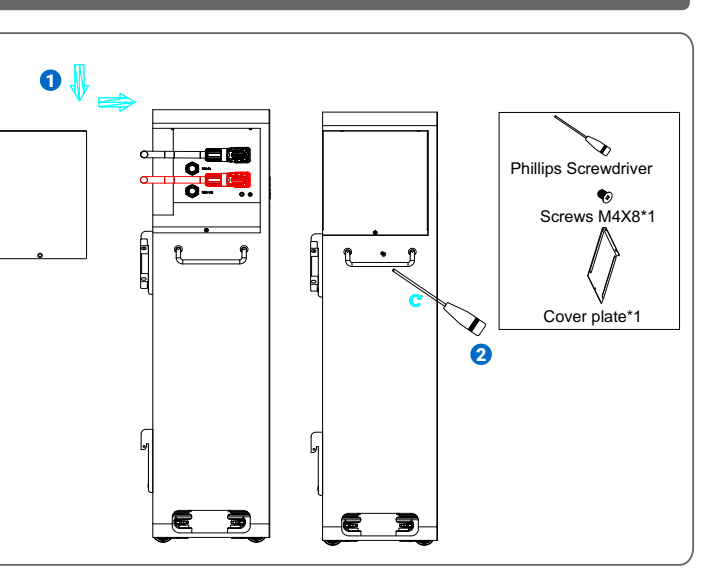

08 Power On/Off Operation

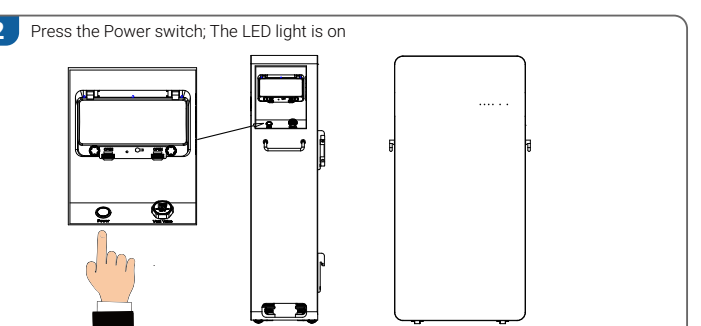
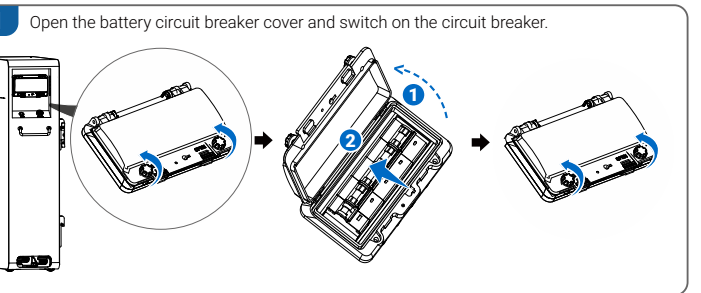
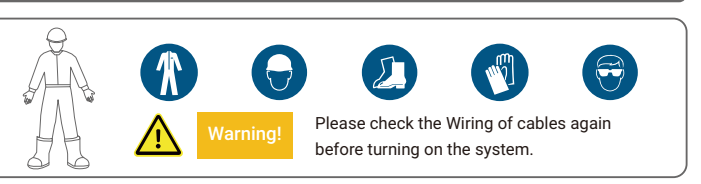

Definition Of Led Indicator Lights:

Table 1 LED Working status indication

State	operating status	ALM	RUN	SOC Indication LEDs				Instructions
				L4	L3	L2	L1	
Power Off	Sleep	OFF	OFF	OFF	OFF	OFF	OFF	All off
Standby	Normal	OFF	Flash1	OFF	OFF	OFF	OFF	Standby
	Normal	OFF	ON	Indication by SOC				Maximum power LED flash(Flash 2)
Charge	Alarm	OFF	ON	Indication by SOC				
	Over Charge Protection	OFF	Flash1	OFF	OFF	OFF	OFF	
	Temperature. Over-current	ON	Flash1	OFF	OFF	OFF	OFF	
	Fault Protection	ON	Flash1	OFF	OFF	OFF	OFF	
Discharge	Normal	OFF	Flash1	Indication by SOC				Indication by SOC
	Alarm	OFF	Flash1	Indication by SOC				
	Temperature. Over-current. Short Circuit	ON	OFF	OFF	OFF	OFF	OFF	Close discharge, Standby time more than 48 hours (without communication, no charge and discharge, no mains power)
	Fault Protection	ON	OFF	OFF	OFF	OFF	OFF	
	Over Charge Protection	OFF	OFF	OFF	OFF	OFF	OFF	

Table2 Capacity indication

State	Capacity indicator light	Charge				Discharge			
		L4	L3	L2	L1	L4	L3	L2	L1
SOC	0 ~ 25%	OFF	OFF	OFF	Flash2	OFF	OFF	OFF	ON
	25 ~ 50%	OFF	OFF	Flash2	ON	OFF	OFF	ON	ON
	50 ~ 75%	OFF	Flash2	ON	ON	OFF	ON	ON	ON
	≥75%	Flash2	ON	ON	ON	ON	ON	ON	ON
Running light(white)		ON				Flash3			

Table 3 LED Flash description

FLASH	on	OFF
Flash1	0.25S	3.75S
Flash2	0.5S	0.5S
Flash3	0.5S	1.5S

Power Off Procedure:



09 Product Parameter

Seris	IntelliHome-16kWh-0D
Performance parameters	
Cell Type	LiFePO4
Rated Energy	16.0kWh
Series And Parallel Connections	1P16S
Nominal Voltage	DC 51.2V
Operating Voltage	DC 44.8...57.6V
Rated Capacity	314Ah
Recommended Charge &Discharge Rate	0.5C
Recommended Charge &Discharge Current	DC 157A
Maximum Continuous Charging Current	DC 157A
Maximum Continuous Discharge Current	DC 157A
Peak Charge/Discharge Current(@25℃, 10s)	DC 235A/235A
Peak Charge/Discharge Current(@25℃, 12s)	DC 204A/204A
Operating Ambient Temperature For Charging	-20~55℃ (with heating function)>45℃,derating)
Operating Ambient Temperature For Discharging	-20~55℃ (>45℃,derating)
Communication Port(Between Parallel Battery Systems)	RS485 channel
Communication Port(Between PCS And Battery System)	CAN channel
Cycle Life ^①	>6000 Cycles/10Years
Expansion capability	Up to 8 units in parallel
Standard parameters	
Cooling Method	Natural Cooling
Certifications &Safety Standards	IEC 62619, IEC 63056, ISO13849, VDE 2510-50, UN 38.3, EN/IEC61000-6-1/2/3/4, IEC 60730-1, IEC 60529 (IP) , SA TS 5389, IEC62040, UV test, CEC list
Compatible Inverters	S6-EH1P(3-6)K-L-L-EU/S5-EH1P(3-6)K-L(Smart)/S6-EH1P(3-10)K-L-PLUS/S6-EH1P(9.9-18)K03-NV-YD-L/S6-EH2P(5-8)K02-SV-YD-L/S6-EH2P(9.6-16)K03-SV-YD-L-US/S6-EH3P(8-18)K02-NV-YD-L/S6-EH3P(7-10)K02-LV-YD-L/SS-EA1P3K-L/S6-EA1P(3.6-6)K-L/S6-E01P(4-6)K-48/S6-E01P(4-5)K-48-EU
Dimensions [W×H×D]	470+/-2.0×950+/-2.0×240+/-1.5mm
Weight	121.5kg+/-3kg
Protection Level Ingress protection	IP66
Pollution Levels	IEC60664-1 Level III
Protection Class	Class I
Mounting	Floor-mounted (default)/ Wall-mounted
Environmental Protection Standards	ROHS, Reach
UN Transportation Test Standard	Shipping, Land transportation
Recommended Operating Temperature	10~45℃
Maximum Operating Altitude	≤4000m(>2000m,derating)
Operating ambient humidity	5~95%RH
Noise Level	≤30db

^①Test conditions:@25℃0.5C/0.5C,70%EOL@100%DOD

10 Packaging, Transportation, Storage

- The system cabinet is packed in cardboard packaging and the internal PE packaging bag is moisture-proof and waterproof.
- Use EPE pearl cotton foam pad in the middle to prevent damage to the system during handling and transportation.
- Transportation must comply with UN3480's dangerous goods transportation and local laws and regulations.
- The system is heavy and must use the mechanical handling.
- Transportation temperature: -10 ° C ~ 40 ° C.
- The equipment and packaging cannot be sprayed, so it cannot be transported in the open air. Storage temperature:
 - 0 ° C ~ 35 ° C, 12months;
 - 20 ° C ~ 45 ° C, 1month; (Delivery SOC status)
- Storage humidity: 5%~95%RH (No condensation)
- The storage room should be kept ventilated, the room should be clean and dry, and it should be protected from dust and moisture.

The storage time can be up to 6 months. It is recommended to charge and discharge the system for more than the time.

Storage room sunlight cannot be directly exposed to the system.

Ginlong Energy Storage Co., Ltd.

Address: No. 57 Jintong Road, Binhai Industrial Park, DongChen, Xiangshan, 315712 Ningbo, Zhejiang, PEOPLE'S REPUBLIC OF CHINA
 Tel: +86(0)574 6578 1806 Email: info@ginlong.com
 Web: www.solisstorage.com